

1/4" NPT PORTS
2 PORTS @ 90° @ 1.5 IN CENTERS

3/8" NPT INLETS
BOTH ENDS

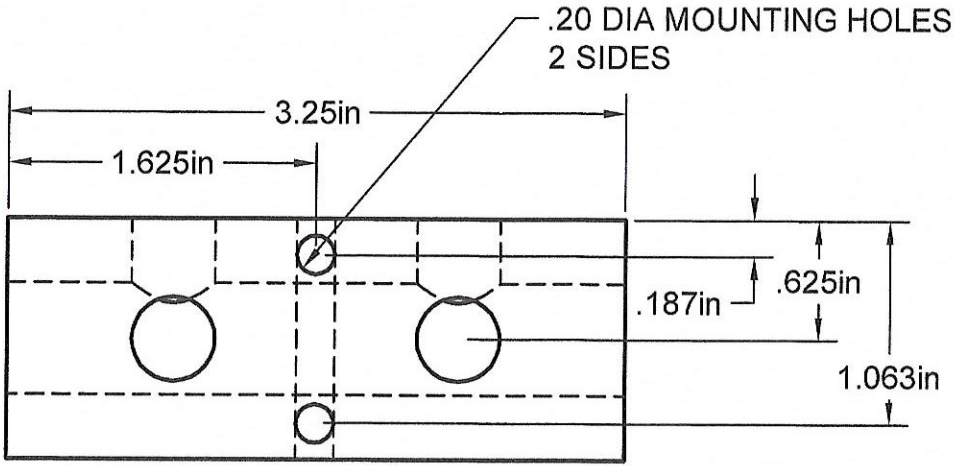

.20 DIA MOUNTING HOLES
2 SIDES

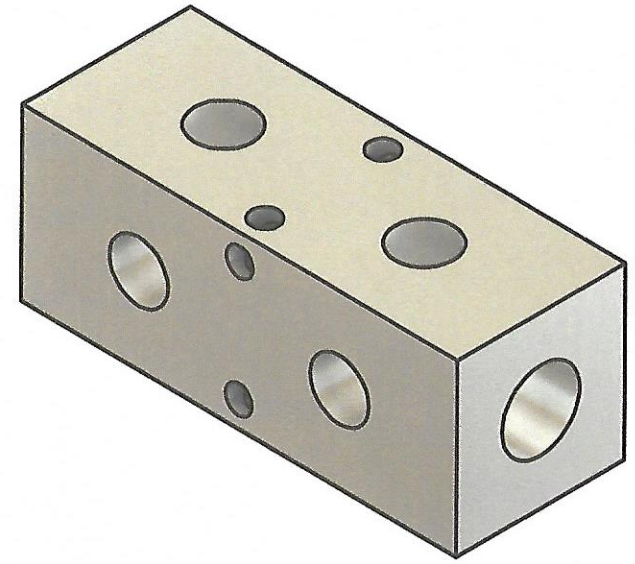
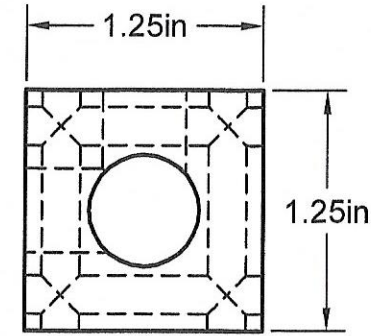

Manifold Material: 6061-T6 Aluminum

Part Number: MS0802-90

**MANIFOLD
SUPPLY**
www.a1manifolds.com
Email: sales@a1manifolds.com