

1/2" NPT PORTS
4 PORTS @ 90° @
2.25 IN CENTERS

1 1/4" NPT INLET
BOTH ENDS

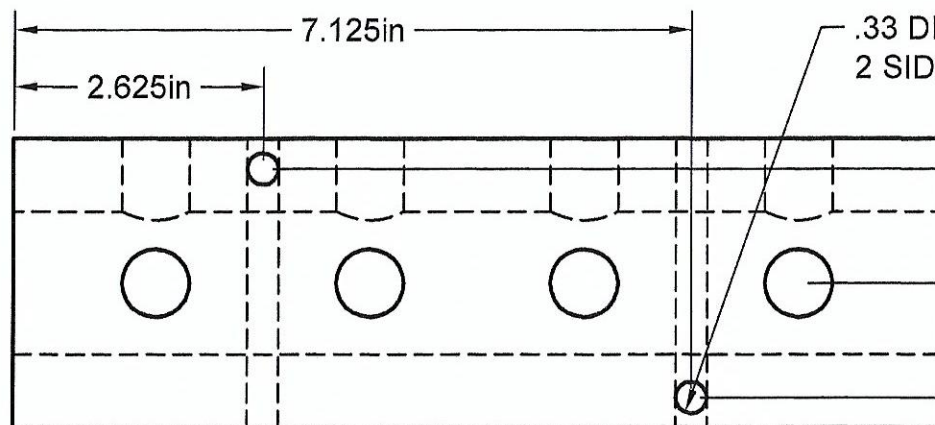

.33 DIA MOUNTING HOLES
2 SIDES

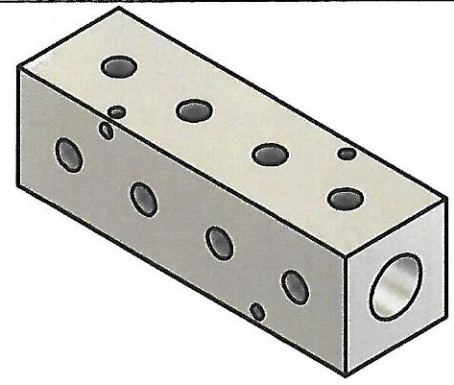
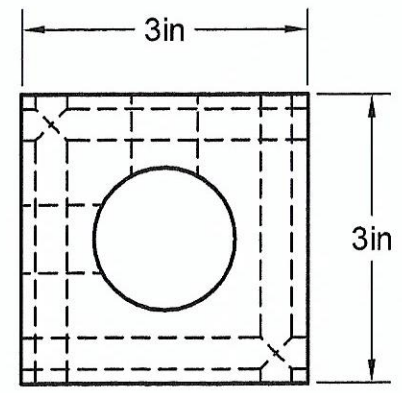

Manifold Material: 6061-T6 Aluminum

Part Number: MS1704-90

**MANIFOLD
SUPPLY**
www.a1manifolds.com
Email: sales@a1manifolds.com