

1/2" NPT PORTS
4 PORTS @
2.25 IN CENTERS

1 1/4" NPT INLET
BOTH ENDS

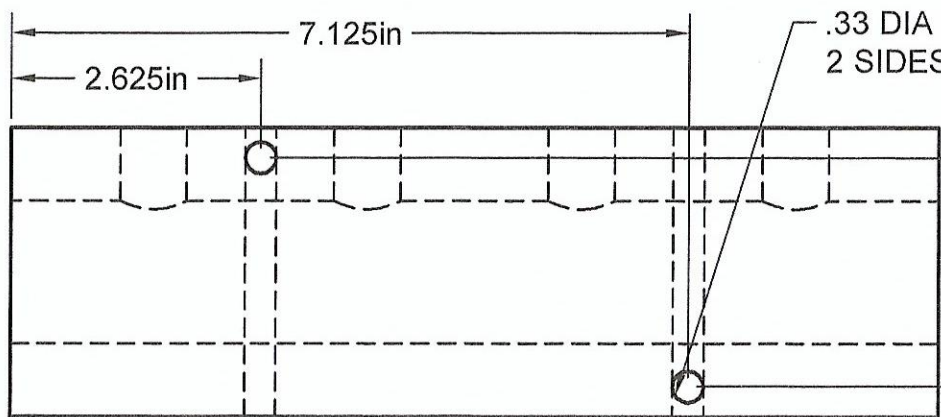
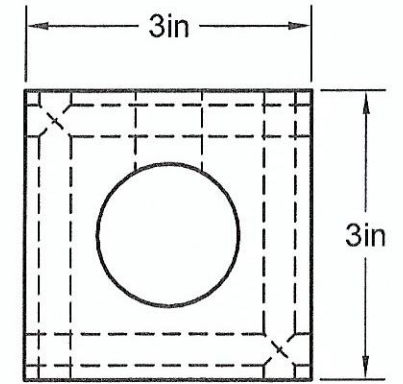
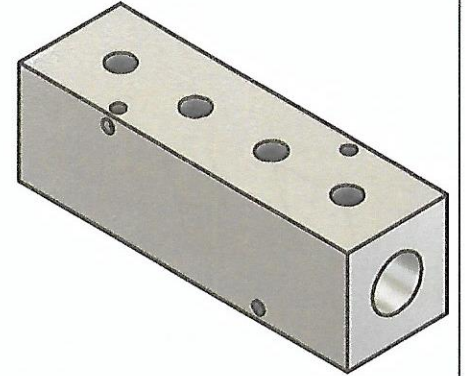

.33 DIA MOUNTING HOLES
2 SIDES

Part Number: MS1704

A1 MANIFOLD SUPPLY
www.a1manifolds.com
 Email: sales@a1manifolds.com

Manifold Material: 6061-T6 Aluminum