

$\frac{3}{8}$ " NPT PORTS
5 PORTS @
1.50 IN CENTERS

$\frac{1}{2}$ " NPT INLET
BOTH ENDS

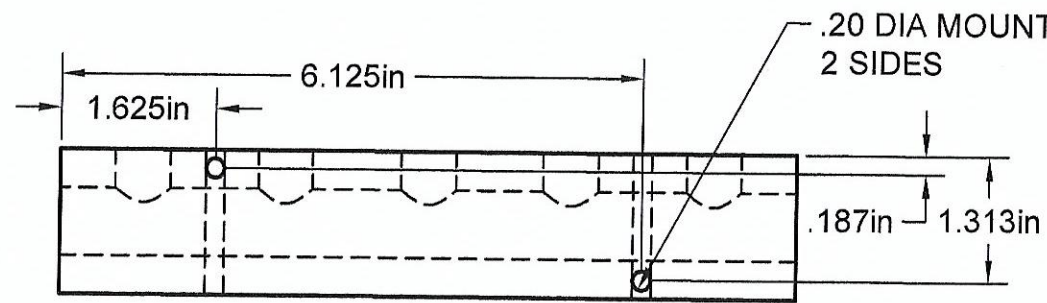
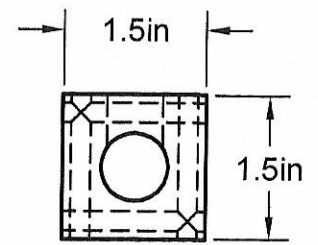
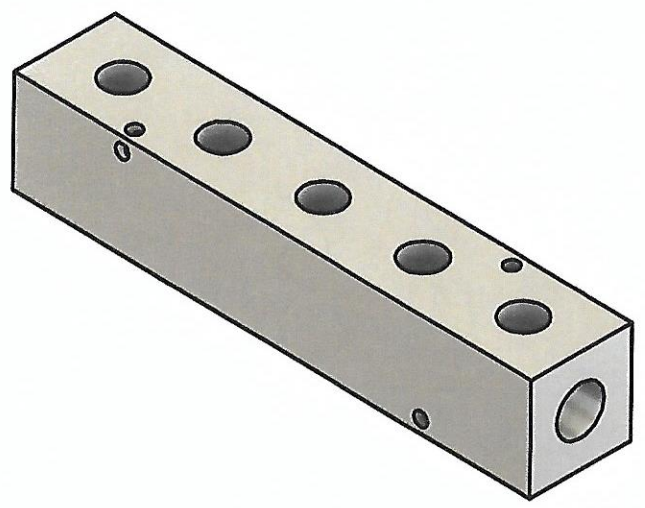

.20 DIA MOUNTING HOLES
2 SIDES

Manifold Material: 6061-T6 Aluminum

Part Number: MS1005

A1 MANIFOLD SUPPLY
www.a1manifolds.com
 Email: sales@a1manifolds.com