

1/8" NPT PORTS
6 PORTS @ 1.50 IN CENTERS

1/4" NPT INLET
BOTH ENDS

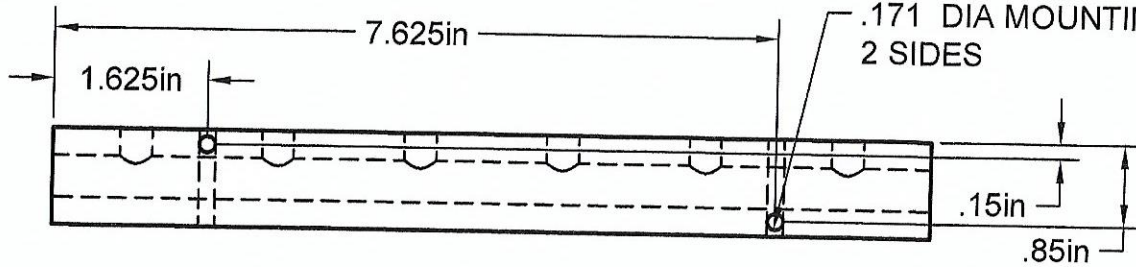
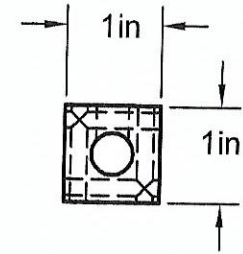
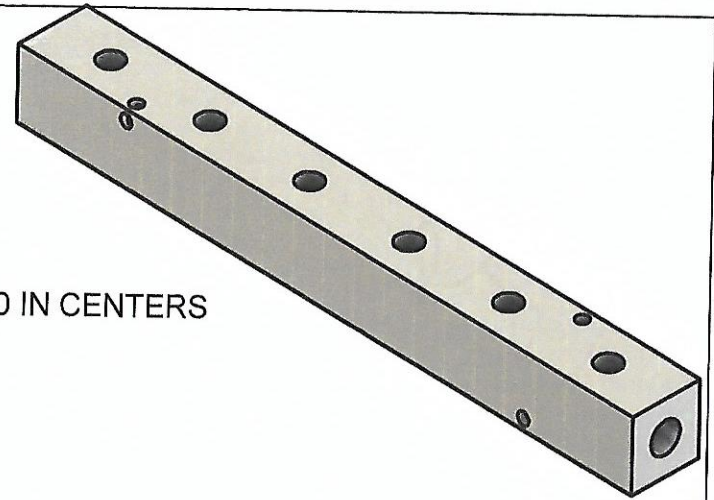

.171 DIA MOUNTING HOLES
2 SIDES

Part Number: MS0606

A1 MANIFOLD SUPPLY
www.a1manifolds.com
Email: sales@a1manifolds.com

Manifold Material: 6061-T6 Aluminum